

POWER RELAY

1 POLE - 16A Relay

FTR-K2 Series

■ FEATURES

- SPST-NO
- High insulation
Insulation distance: minimum 6mm between coil and contact
Dielectric strength: 4KV
Surge strength: 10KV
- TV-5 rating
- Heat resistance, flammability
Class B (130° C) wire class, flammability 94V-0
- Cadmium free contact for eco-program
- Safety standards
UL, CSA, VDE approved
UL/CSA TV-5 rating approved
- Flux proof sealing, RTII
- RoHS compliant
Please see page 6 for more information



■ PARTNUMBER INFORMATION

[Example] FTR-K2 A K 012 T - OK
 (a) (b) (c) (d) (e) (f)

(a)	Relay type	FTR-K2	: FTR-K2-Series
(b)	Contact configuration	A	: 1 form A (SPST-NO)
(c)	Coil type	K	: Standard type (530mW)
(d)	Coil rated voltage	012	: 5.....48 VDC Coil rating table at page 3
(e)	Contact material / TV type	T	: Silver-tin oxide / TV-5
(f)	Special type	None TH	: Standard (TV-5) : TV-8 rating

Actual marking does not carry the type name : "FTR"
 E.g.: Ordering code: FTR-K2AK012T Actual marking: K2AK012T

■ SPECIFICATION

Item			FTR-K2AK () T
Contact Data	Configuration		1 form A (SPST-NO)
	Construction		Single
	Material		Silver tin oxide (AgSnO ₂)
	Resistance (initial)		Max. 100mΩ at 1A, 6VDC
	Contact rating (resistive)		250VAC / 30VDC / 16A
	Max. carrying current		16A
	Max. switching voltage		400VAC / 300VDC
	Max. switching power		4,000VA / 480W
	Min. switching load*		100mA, 5VDC
Life	Mechanical		Min. 2 x 10 ⁶ operations
	Electrical	DC contact rating	Min. 100 x 10 ³ operations
		AC contact rating	Min. 100 x 10 ³ operations
		Lamp load (TV-5)	Min. 25 x 10 ³ operations
Coil Data	Rated power (20 °C)		530mW
	Operate power (20 °C)		260mW
	Operating temperature range		-40 °C to +70 °C (no frost)
Timing Data	Operate (at nominal voltage)		Max. 15ms (without bounce)
	Release (at nominal voltage)		Max. 5ms (without bounce)
Insulation	Resistance (initial)		Min. 1,000MΩ at 500VDC
	Dielectric strength	Open contacts	1,000VAC (50/60Hz) 1min
		Contacts to coil	4,000VAC (50/60Hz) 1min
	Surge strength	Coil to contacts	10,000V / 1.2 x 50μs standard wave
	Clearance		6mm
	Creepage		6mm
	EN61810-1, VDE0435	Voltage	250V
		Pollution degree	3
		Material group	III a
	Category	B / 250V	
Other	Vibration resistance	Misoperation>1us	10 to 55 to 10Hz single amplitude 0.75mm
		Endurance	10 to 55 to 10Hz single amplitude 0.75mm
	Shock	Misoperation>1us	200m/s ² (11 ± 1ms)
		Endurance	1,000m/s ² (6 ± 1ms)
	Weight		Approximately 13g
	Sealing		Flux proof (RT II)

* Minimum switching loads mentioned above are reference values. Please perform the confirmation test with actual load before production since reference values may vary according to switching frequencies, environmental conditions and expected reliability levels.

Care shall be taken on the heat generated on PC board when maximum carrying current exceeds 10A. Please perform the confirmation test with actual conditions.

■ COIL RATING

Coil Code	Rated Coil Voltage (VDC)	Coil Resistance +/- 10% (Ohm)	Must Operate Voltage (VDC) *	Must Release Voltage (VDC) *	Rated Power (mW)
003	3	17	2.1	0.15	530
005	5	47	3.5	0.25	
006	6	68	4.2	0.3	
009	9	155	6.3	0.45	
012	12	270	8.4	0.6	
018	18	610	12.6	0.9	
024	24	1,110	16.8	1.2	
048	48	4,400	33.6	2.4	

Note: All values in the table are valid for 20°C and zero contact current.

* Specified operate values are valid for pulse wave voltage.

Please use at rated coil voltage. Please refer to characteristic data and set up adequate voltage in case of use at over voltage.

■ SAFETY STANDARDS

Type	Compliance	Contact rating
UL	UL 508	Flammability: UL 94-V0 (plastics)
	E63614	16A, 30VDC (resistive) 15A, 140VAC (resistive)
CSA	C22.2 No. 14 LR 40304	10A, 277VAC (resistive)
		1/2 HP, 125VAC (UL), 1/3 HP 125VAC (CSA) TV-5, 120 VAC , TV-8, 120VAC Pilot duty: A300 (UL), C300 (CSA)
VDE	IEC/EN61810-1 EN60065 clause 14.6.1	16A, 250 VAC (cosφ=1) 8A, 250 VAC cosφ=0.4) 16A, 30 VDC (0ms) 250VAC 5/80A inrush
CQC	GB/T21711-1 GB15092-1 03001008195	<FTR-K2AK()T> 16A 250VAC

CHARACTERISTIC DATA

(Characteristic data is not guaranteed value but measured values of samples from production line.)

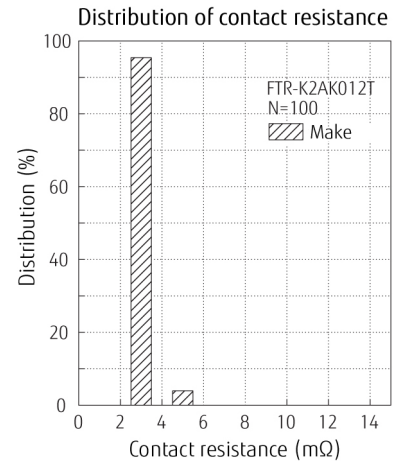
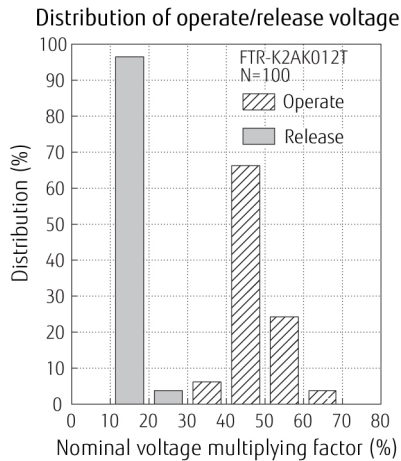
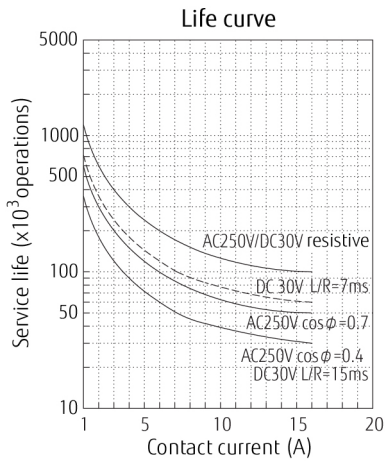
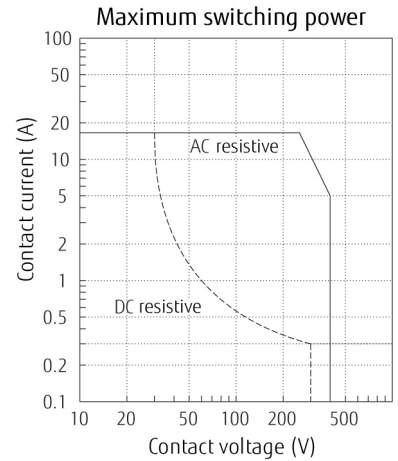
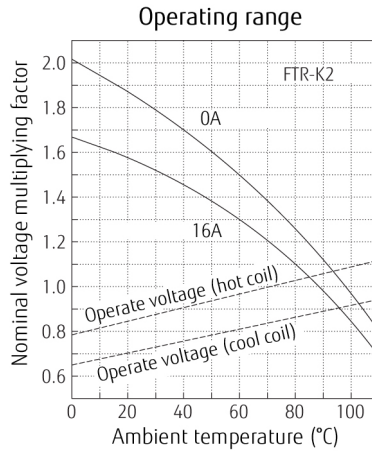
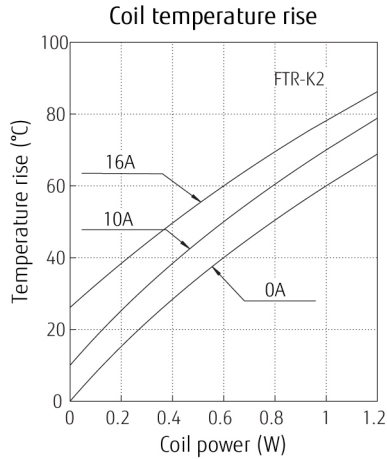

■ DIMENSIONS

● Dimensions

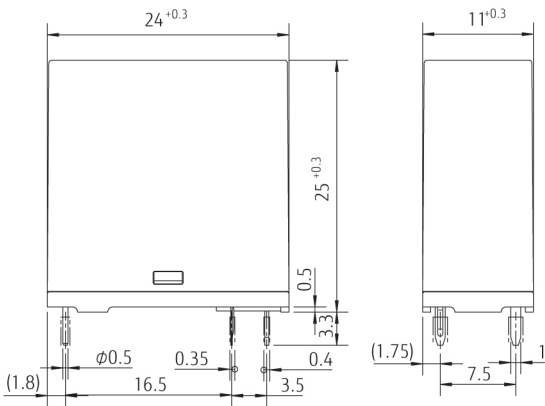

● Schematics

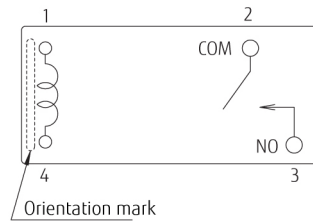

● PC board mounting hole layout (BOTTOM VIEW)

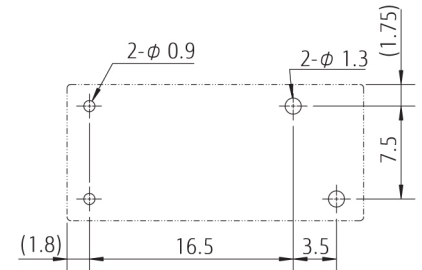

Unit: mm

- * Dimensions of the terminals do not include thickness of pre-solder.
- * Tolerance of PC board mounting hole layout : ± 0.1 unless otherwise specified

Cautions

- All values mentioned in this datasheet are provided under ideal conditions. Please perform the confirmation test before actual use.
- Reflow soldering is prohibited.
- Do not use relays in the atmosphere with sulfide gas, chloride gas or nitric oxide. Contact resistance may increase.
- Do not use silicon or silicon-containing product or materials near relays. It may cause contact failure.

RoHS Compliance and Lead Free Information

1. General Information

- All relays produced by Fujitsu Components are compliant with RoHS directive 2011/65/EU including amendments.
- Cadmium as used in electrical contacts is exempted from the RoHS directives. As per Annex III of directive 2011/65/EU.
- All relays are lead-free. Please refer to Lead-Free Status Info for older date codes at: <http://www.fujitsu.com/downloads/MICRO/fcai/relays/lead-free-letter.pdf>
- Lead free solder plating on relay terminals is Sn-3.0Ag-0.5Cu, unless otherwise specified. This material has been verified to be compatible with PbSn assembly process.

2. Recommended Lead Free Solder Condition

- Recommended solder Sn-3.0Ag-0.5Cu.

Flow Solder Condition:

Pre-heating: maximum 120°C
within 90 sec.
Soldering: dip within 5 sec. at
255°C ± 5°C solder bath
Relay must be cooled by air immediately
after soldering

Solder by Soldering Iron:

Soldering Iron 30-60W
Temperature: maximum 350-360°C
Duration: maximum 3 sec.

We highly recommend that you confirm your actual solder conditions

3. Moisture Sensitivity

- Moisture Sensitivity Level standard is not applicable to electromechanical relays, unless otherwise indicated.

4. Tin Whiskers

- Dipped SnAgCu solder is known as presenting a low risk to tin whisker development. No considerable length whisker was found by our in house test.

Fujitsu Components International Headquarter Offices

Japan FUJITSU COMPONENT LIMITED Shinagawa Seaside Park Tower 19F, 12-4, Higashi-shinagawa 4-chome, Shinagawa-ku, Tokyo, 140-0002, Japan Tel: (81-3) 3450-1682 Fax: (81-3) 3474-2385 Email: fcl-contact@cs.jp.fujitsu.com Web: www.fujitsu.com/jp/fcl/	Asia Pacific FUJITSU COMPONENTS ASIA, LTD. 102E Pasir Panjang Road #01-01 Citilink Warehouse Complex Singapore 118529 Tel: (65) 6375-8560 Fax: (65) 6273-3021 Email: fcal@sg.fujitsu.com Web: www.fujitsu.com/sg/products/devices/components	Korea FUJITSU COMPONENTS KOREA LIMITED Alpha Tower #403, 645 Samsyeong-dong, Bundang-gu, Seongnam-si, Gyeonggi-do, 13524 Korea Tel: (82) 31-708-7108 Fax: (82) 31-709-7108 Email: fcal@sg.fujitsu.com www.fujitsu.com/sg/products/devices/components/
North and South America FUJITSU COMPONENTS AMERICA, INC 2290 North First Street, Suite 212 San Jose, CA 95131, USA Tel: (1-408) 745-4900 Fax: (1-408) 745-4970 Email: components@us.fujitsu.com Web: us.fujitsu.com/components	China FUJITSU ELECTRONIC COMPONENTS (SHANGHAI) CO., LTD. Unit 4306, InterContinental Center 100 Yu Tong Road, Shanghai 200070, China Tel: (86-21) 3253 0998 Fax: (86-21) 3253 0997 Email: fcal@sg.fujitsu.com Web: www.fujitsu.com/sg/products/devices/components	
Europe FUJITSU COMPONENTS EUROPE B.V. Diamantlaan 25 2132 WV Hoofddorp Netherlands Tel: (31-23) 5560910 Fax: (31-23) 5560950 Email: info@fceu.fujitsu.com Web: www.fujitsu.com/uk/components	Hong Kong FUJITSU COMPONENTS HONG KONG CO., LTD Unit 506, Inter-Continental Plaza No.94 Granville Road, Tsim Sha Tsui, Kowloon, Hong Kong Tel: (852) 2881-8495 Tex: (852) 2894-9512 Email: fcal@sg.fujitsu.com Web: www.fujitsu.com/sg/products/devices/components/	

©2018 Fujitsu Components Europe B.V. All rights reserved. All trademarks or registered trademarks are the property of their respective owners.

The contents, data and information in this datasheet are provided by Fujitsu Component Ltd. as a service only to its user and only for general information purposes.

The use of the contents, data and information provided in this datasheet is at the users' own risk.

Fujitsu has assembled this datasheet with care and will endeavor to keep the contents, data and information correct, accurate, comprehensive, complete and up to date.

Fujitsu Components Europe B.V. and affiliated companies do however not accept any responsibility or liability on their behalf, nor on behalf of its employees, for any loss or damage, direct, indirect or consequential, with respect to this datasheet, its contents, data, and information and related graphics and the correctness, reliability, accuracy, comprehensiveness, usefulness, availability and completeness thereof.

Nor do Fujitsu Components Europe B.V. and affiliated companies accept on their behalf, nor on behalf of its employees, any responsibility or liability for any representation or warrant of any kind, express or implied, including warranties of any kind for merchantability or fitness for particular use, with respect to these datasheets, its contents, data, information and related graphics and the correctness, reliability, accuracy, comprehensiveness, usefulness, availability and completeness thereof. Rev. April 24th, 2018